

eZdspTM F2804x

*Technical
Reference*

eZdsp™ F2804x
Technical Reference

509165-0001 Rev. B
November 2006

SPECTRUM DIGITAL, INC.
12502 Exchange Dr., Suite 440 Stafford, TX. 77477
Tel: 281.494.4505 Fax: 281.494.5310
sales@spectrumdigital.com www.spectrumdigital.com

IMPORTANT NOTICE

Spectrum Digital, Inc. reserves the right to make changes to its products or to discontinue any product or service without notice. Customers are advised to obtain the latest version of relevant information to verify data being relied on is current before placing orders.

Spectrum Digital, Inc. warrants performance of its products and related software to current specifications in accordance with Spectrum Digital's standard warranty. Testing and other quality control techniques are utilized to the extent deemed necessary to support this warranty.

Please be aware, products described herein are not intended for use in life-support appliances, devices, or systems. Spectrum Digital does not warrant, nor is it liable for, the product described herein to be used in other than a development environment.

Spectrum Digital, Inc. assumes no liability for applications assistance, customer product design, software performance, or infringement of patents or services described herein. Nor does Spectrum Digital warrant or represent any license, either express or implied, is granted under any patent right, copyright, or other intellectual property right of Spectrum Digital, Inc. covering or relating to any combination, machine, or process in which such Digital Signal Processing development products or services might be or are used.

WARNING

This equipment is intended for use in a laboratory test environment only. It generates, uses, and can radiate radio frequency energy and has not been tested for compliance with the limits of computing devices pursuant to subpart J of part 15 of FCC rules, which are designed to provide reasonable protection against radio frequency interference. Operation of this equipment in other environments may cause interference with radio communications, in which case the user, at his own expense, will be required to take any measures necessary to correct this interference.

TRADEMARKS

eZdsp is a trademark of Spectrum Digital, Inc.

Contents

1	Introduction to the eZdsp™ F2804x	1-1
	<i>Provides a description of the eZdsp™ F2804x, key features, and board outline.</i>	
1.0	Overview of the eZdsp™ F2804x	1-2
1.1	Key Features of the eZdsp™ F2804x	1-2
1.2	Functional Overview of the eZdsp™ F2804x	1-3
2	Operation of the eZdsp™ F2804x	2-1
	<i>Describes the operation and various interfaces of the eZdsp™ F2804x.</i>	
2.0	The eZdsp™ F2804x Operation	2-2
2.1	The eZdsp™ F2804x Board	2-2
2.1.1	Power Connector	2-3
2.2	eZdsp™ F2804x Memory	2-3
2.2.1	Memory Map	2-4
2.3	eZdsp™ F2804x Connectors	2-5
2.3.1	P1, JTAG Interface	2-7
2.3.2	J201, USB Port/JTAG Interface	2-8
2.3.3	P4,P8,P7, I/O Interface	2-8
2.3.4	P5,P9, Analog Interface	2-10
2.3.5	P6, Power Connector	2-11
2.3.6	P10, RS-232 Connector	2-12
2.3.7	Connector Part Numbers	2-13
2.4	eZdsp™ F2804x Jumpers	2-14
2.4.1	JP4, Voltage Jumper, +3.3/5 Volts for P8, P4	2-14
2.4.2	JP5, ADCREFIN Select	2-15
2.4.3	JP6, GPIO22/GPIO24 Select	2-15
2.5	Switches	2-16
2.5.1	Switch SW1	2-16
2.5.1.1	Switch SW1, Position 1-3, Boot Mode Select	2-17
2.5.1.2	Switch SW1, Position 4, EEPROM Write Enable/Disable	2-17
2.5.1.3	Switch SW1, Position 5, Select EEPROM Pull-ups	2-18
2.5.1.4	Switch SW1, Position 6, Serial EEPROM Address A1	2-18
2.5	Switch SW2	2-19
2.6	LEDS	2-19
2.7	Test Points	2-20
A	eZdsp™ F2804x Schematics	A-1
	<i>Contains the schematics for the socketed and unsocketed versions of the eZdsp™ F2804x</i>	
B	eZdsp™ F2804x Mechanical Information	B-1
	<i>Contains the mechanical information about the socketed and unsocketed versions of the eZdsp™ F2804x</i>	

List of Figures

Figure 1-1, Block Diagram eZdsp™ F2804x	1-3
Figure 2-1, eZdsp™ F2804x PCB Outline	2-2
Figure 2-2, eZdsp™ F2804x Memory Space	2-4
Figure 2-3, eZdsp™ F2804x Connector and Switch Positions	2-6
Figure 2-4, Connector P1 Pin Locations	2-7
Figure 2-5, Connector P8 Connector	2-8
Figure 2-6, Connector P5/P9 Pin Locations	2-10
Figure 2-7, Connector P6 Location	2-11
Figure 2-8, eZdsp™ F2804x Power Connector	2-11
Figure 2-9, P10, DB9 Female Connector	2-12
Figure 2-10, eZdsp™ F2804x Jumper Positions (Bottom Side)	2-14
Figure 2-11, JP4 Layout	2-14
Figure 2-12, JP6 Layout	2-15
Figure 2-13, SW1 Layout	2-16
Figure 2-14, SW2 Layout	2-19

List of Tables

Table 2-1, eZdsp™ F2804x Connectors	2-5
Table 2-2, P1, JTAG Interface Connector	2-7
Table 2-3, P4/P8, I/O Connectors	2-9
Table 2-4, P5/P9, Analog Interface Connector	2-10
Table 2-5, P10, RS-232 Pinout	2-12
Table 2-6, eZdsp™ F2804x Suggested Connector Part Numbers	2-13
Table 2-7, eZdsp™ F2804x Jumpers	2-13
Table 2-8, JP4, +3.3/5 Volts to P8	2-14
Table 2-9, JP6, GPIO22/GPIO24 Select	2-15
Table 2-10, SW1, Switch Positions	2-16
Table 2-11, SW1, Positions 1-3	2-17
Table 2-12, SW1, Position 4	2-17
Table 2-13, SW1, Position 5	2-18
Table 2-14, SW1, Position 6	2-18
Table 2-15, SW2, Switch Positions	2-19
Table 2-16, LEDs	2-19
Table 2-17, Test Points	2-20

About This Manual

This document describes board level operations of the eZdsp™ F2804x based on the Texas Instruments TMS320F2804x Digital Signal Processor.

The eZdsp™ F2804x is a stand-alone module permitting engineers and software developers evaluation of certain characteristics of the TMS320F2804x DSP to determine processor applicability to design requirements. Evaluators can create software to execute onboard or expand the system in a variety of ways.

Notational Conventions

This document uses the following conventions.

The “eZdsp™ F2804x” will sometimes be referred to as the “eZdsp”.

“eZdsp” will include the socketed or unsocketed version

Program listings, program examples, and interactive displays are shown in a special italic typeface. Here is a sample program listing.

```
equations  
!rd = !strobe&rw;
```

Information About Cautions

This book may contain cautions.

This is an example of a caution statement.

A caution statement describes a situation that could potentially damage your software, hardware, or other equipment. The information in a caution is provided for your protection. Please read each caution carefully.

Related Documents

Texas Instruments TMS320F28x DSP CPU and Instruction Set Reference Guide,
literature #SPRU430
Texas Instruments TMS320F28x Assembly Language Tools Users Guide,
literature #SPRU513
Texas Instruments TMS320F28x Optimizing C/C++ Compiler User's Guide,
literature #SPRU514
Texas Instruments Code Composer Studio Getting Started Guide,
literature #SPRU509

Table 1: Manual History

Revision	History
A	Preliminary Release

Table 2: Board History

Revision	History
A	Prototype Release

Chapter 1

Introduction to the eZdsp™ F2804x

This chapter provides a description of the eZdsp™ for the TMS320F2804x Digital Signal Processor, key features, and block diagram of the circuit board.

Topic	Page
1.0 Overview of the eZdsp™ F2804x	1-2
1.1 Key Features of the eZdsp™ F2804x	1-2
1.2 Functional Overview of the eZdsp™ F2804x	1-3

1.0 Overview of the eZdsp™ F2804x

The eZdsp™ F2804x is a stand-alone card--allowing evaluators to examine the TMS320F2804x digital signal processor (DSP) to determine if it meets their application requirements. Furthermore, the module is an excellent platform to develop and run software for the TMS320F2804x processor.

The eZdsp™ F2804x is shipped with a TMS320F2804x DSP. The eZdsp™ F2804x allows full speed verification of F2804x code. Expansion connectors are provided for any necessary evaluation circuitry not provided on the as shipped configuration.

To simplify code development and shorten debugging time, a C2000 Tools Code Composer driver is provided. In addition, an onboard JTAG connector provides interface to emulators, operating with other debuggers to provide assembly language and 'C' high level language debug.

1.1 Key Features of the eZdsp™ F2804x

The eZdsp™ F2804x has the following features:

- TMS320F2804x Digital Signal Processor
- 100 MIPS operating speed
- 10K words on-chip zero wait state SARAM
- 128K words on-chip Flash memory
- 256K bits serial I²C EEPROM memory
- 20 MHz. clock
- Expansion Connectors (analog, I/O)
- Onboard IEEE 1149.1 JTAG Controller
- 5-volt only operation with supplied AC adapter
- TI F28xx Code Composer Studio tools driver
- On board USB JTAG emulation connector
- 1 SCI UART channel

1.2 Functional Overview of the eZdsp™ F2804x

Figure 1-1 shows a block diagram of the basic configuration for the eZdsp™ F2804x. The major interfaces of the eZdsp are the JTAG interface, and expansion interface.

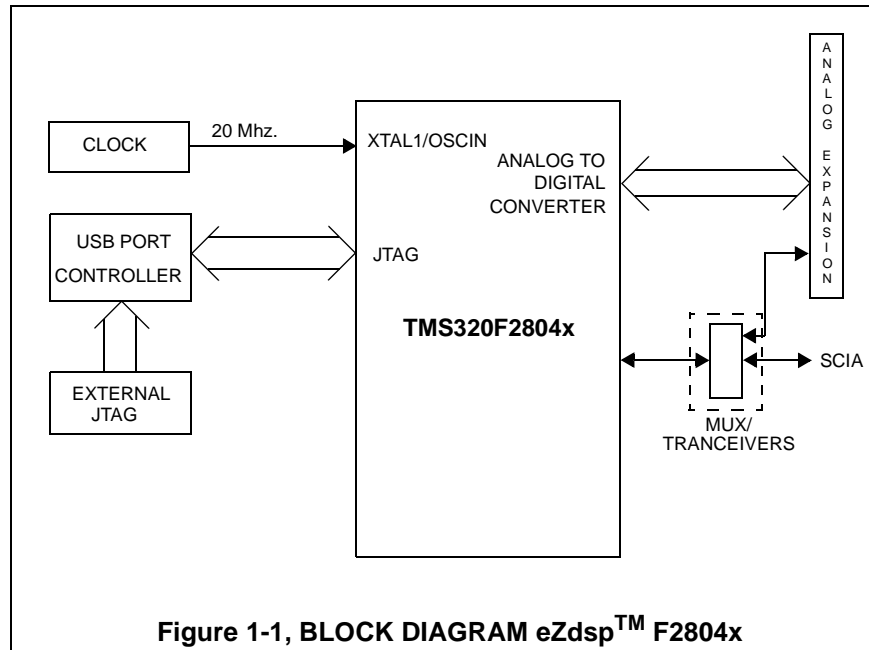

Chapter 2

Operation of the eZdsp™ F2804x

This chapter describes the operation of the eZdsp™ F2804x, key interfaces and includes a circuit board outline.

Topic	Page
2.0 The eZdsp™ F2804x Operation	2-2
2.1 The eZdsp™ F2804x Board	2-2
2.1.1 Power Connector	2-3
2.2 eZdsp™ F2804x Memory	2-3
2.2.1 Memory Map	2-4
2.3 eZdsp™ F2804x Connectors	2-5
2.3.1 P1, JTAG Interface	2-7
2.3.2 J201, USB Port/JTAG Interface	2-8
2.3.3 P8, I/O Interface	2-8
2.3.4 P5,P9, Analog Interface	2-10
2.3.5 P6, Power Connector	2-11
2.3.6 P10, RS-232 Connector	2-12
2.3.7 Connector Part Numbers	2-13
2.4 eZdsp™ F2804x Jumpers	2-13
2.4.1 JP4, Voltage Jumper, +3.3/5 Volts for P8, P4	2-14
2.4.2 JP5, ADCREFIN Select	2-15
2.4.3 JP6, GPIO22/GPIO24 Select	2-15
2.5 Switches	2-16
2.5.1 Switch SW1	2-16
2.5.1.1 Switch SW1, Position 1-3, Boot Mode Select	2-17
2.5.1.2 Switch SW1, Position 4, EEPROM Write Enable/Disable	2-17
2.5.1.3 Switch SW1, Position 5, Select EEPROM Pull-ups	2-18
2.5.1.4 Switch SW1, Position 6, Serial EEPROM Address A1	2-18
2.5.2 Switch SW2	2-19
2.6 LEDs	2-19
2.7 Test Points	2-20

2.0 The eZdsp™ F2804x Operation

This chapter describes the eZdsp™ F2804x, key components, and operation. Information on the eZdsp's various interfaces is also included. The eZdsp™ F2804x consists of four major blocks of logic:

- Analog Interface Connector
- I/O Interface Connector
- JTAG Interface
- USB Port JTAG Controller Interface

2.1 The eZdsp™ F2804x Board

The eZdsp™ F2804x is a 5.25 x 3.0 inch, multi-layered printed circuit board, powered by an external 5-Volt only power supply. Figure 2-1 shows the layout of the top side of the eZdsp™ F2804x.

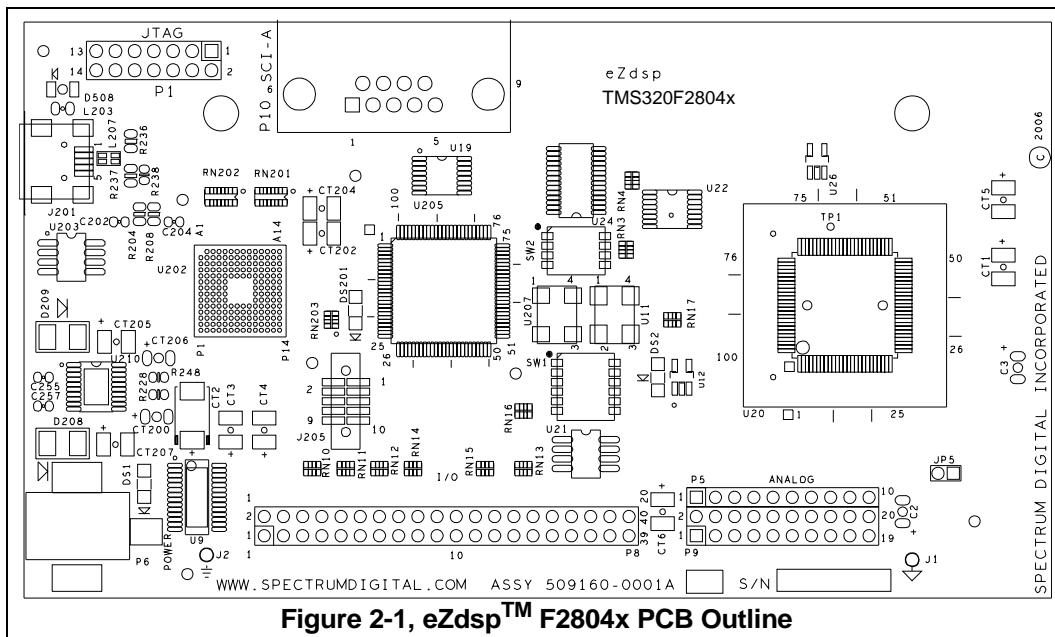

Figure 2-1, eZdsp™ F2804x PCB Outline

2.1.1 Power Connector

The eZdsp™ F2804x is powered by a 5-Volt only power supply, included with the unit. The unit requires 500mA. The power is supplied via connector P6. If expansion boards are connected to the eZdsp, a higher amperage power supply may be necessary. Section 2.3.6 provides more information on connector P6.

2.2 eZdsp™ F2804x Memory

The eZdsp includes the following on-chip memory:

- 2 blocks of 1K x 16 single access RAM (SARAM, M0,M1)
- 1 block of 8K x 16 SARAM (Lo,L1)

The eZdsp can load ram for debug, or Flash can be programmed and run. For larger software projects it is suggested to do a initial debug with on eZdsp F2804x module which supports a total RAM environment. With careful attention to the I/O mapping in the software the application code can easily be ported to the F2804x.

2.2.1 Memory Map

The figure below shows the memory map configuration on the eZdsp™ F2804x.

Block Start Address	F2804x	
	Data Space	Program Space
0x0000-0000	M0 SARAM	
0x0000-0400	M1 SARAM	
0x0000-0800	Peripheral Frame 0	Do Not Use !
0x0000-0D00	Pie Vector Table (256 x 16)	
0x0000-0E00		
0x0000-6000	Peripheral Frame 1	Do Not Use !
0x0000-7000	Peripheral Frame 2 (16 Bit access only)	
0x0000-8000	L0 SARAM	
0x0000-9000	L1 SARAM	
0x0000-A000		
0x003D-7800	OTP (Read Only)	
0x003D-7C00		
0x003D-8000	Flash (Read Only) (128K x 16)	
0x003F-8000	L0 SARAM Mirror	
0x003F-9000	L1 SARAM Mirror	
0x003F-A000		
0x003F-F000	Boot ROM (Read Only)	
0x003F-FFFF		

Figure 2-2, eZdsp™ F2804x Memory Space

2.3 eZdsp™ F2804x Connectors

The eZdsp™ F2804x has five connectors. Pin 1 of each connector is identified by a square solder pad. The function of each connector is shown in the table below:

Table 1: eZdsp™ F2804x Connectors

Connector	Function
P1	JTAG Interface
P8	I/O Interface
P5/P9	Analog Interface
P6	Power Connector
P10	DB-9, RS-232
J201	USB Controller Interface

The diagram below shows the position of each connector

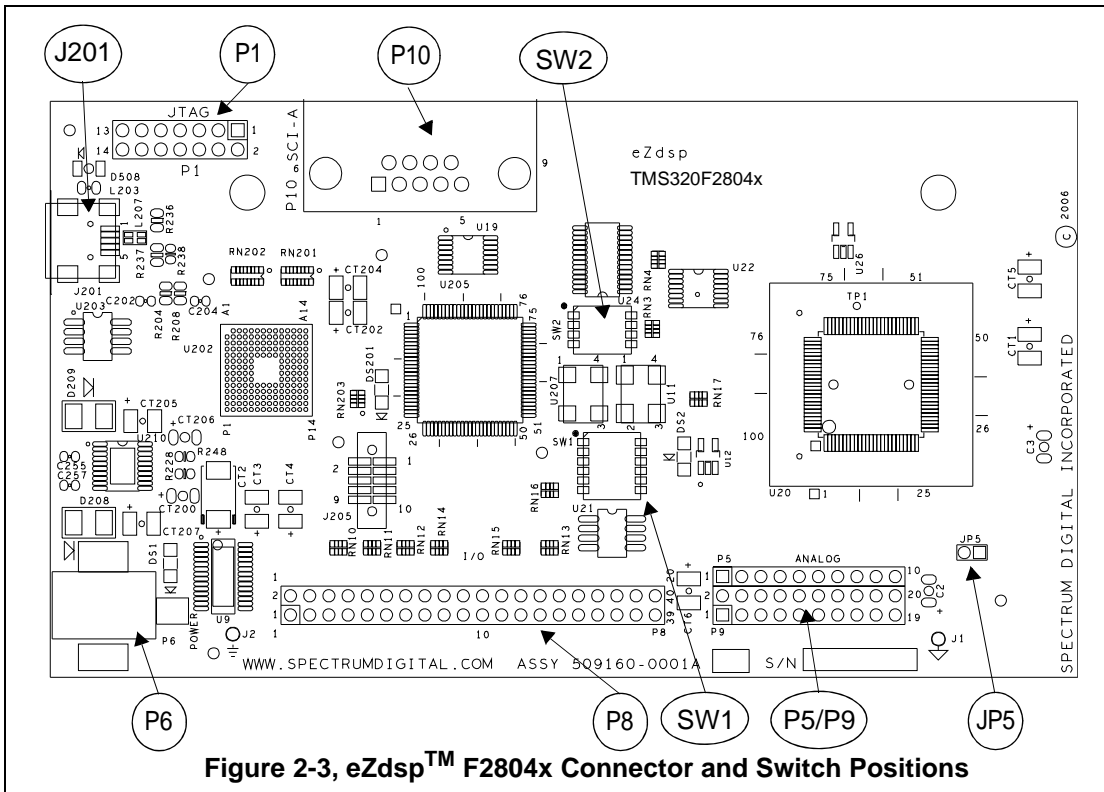

Figure 2-3, eZdsp™ F2804x Connector and Switch Positions

2.3.1 P1, JTAG Interface

The eZdsp™ F2804x is supplied with a 14-pin header interface, P1. This is the standard interface used by JTAG emulators to interface to Texas Instruments DSPs.

The positions of the 14 pins on the P1 connector are shown in the diagram below as viewed from the top of the eZdsp.

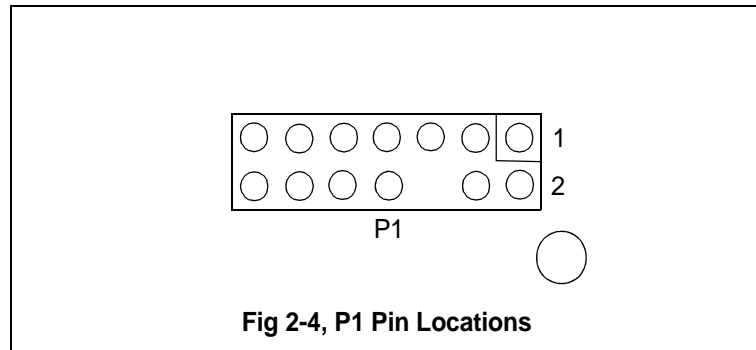

Fig 2-4, P1 Pin Locations

The definition of P1, which has the JTAG signals is shown below.

Table 2: P1, JTAG Interface Connector

Pin #	Signal	Pin #	Signal
1	TMS	2	TRST-
3	TDI	4	GND
5	PD (+5V)	6	no pin
7	TDO	8	GND
9	TCK-RET	10	GND
11	TCK	12	GND
13	EMU0	14	EMU1

2.3.2 J201, USB Port/JTAG Interface

The eZdsp™ F2804x uses a custom USB port JTAG interface device. The device has direct access to the integrated JTAG interface. Drivers for C2000 Code Composer tools are shipped with the eZdsp™ modules

2.3.3 P8, I/O Interface

The connector P8 presents the I/O signals from the DSP. The layout of this connector is shown below.

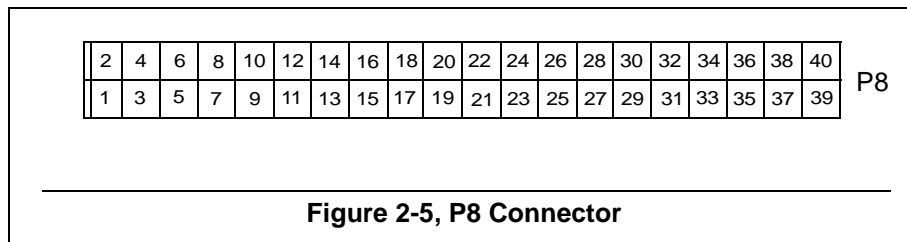

The pin definition of P4/P8 connectors are shown in the table below.

Table 3: P4/P8, I/O Connectors

P8 Pin #	P8 Signal	P8 Pin #	P8 Signal
1	+3.3V/+5V/NC *	2	+3.3V/+5V/NC *
3	MUX_GPIO29	4	MUX_GPIO28
5	GPIO14	6	GPIO20
7	GPIO21	8	GPIO23
9	GPIO0	10	GPIO1
11	GPIO2	12	GPIO3
13	GPIO4	14	GPIO5
15	GPIO27	16	GPIO6
17	GPIO13	18	GPIO34
19	GND	20	GND
21	GPIO7	22	GPIO15
23	GPIO16	24	GPIO17
25	GPIO18	26	GPIO19
27	MUX_GPIO31	28	MUX_GPIO30
29	MUX_GPIO11	30	MUX_GPIO8
31	MUX_GPIO9	32	MUX_GPIO10
33	GPIO22/GPIO24	34	GPIO25
35	GPIO26	36	GPIO32
37	GPIO12	38	GPIO33
39	GND	40	GND

* Default is No Connect (NC). User can jumper to +3.3V or +5V on backside of eZdsp with JP4.

2.3.4 P5/P9, Analog Interface

The position of the 30 pins on the P5/P9 connectors are shown in the diagram below as viewed from the top of the eZdsp.

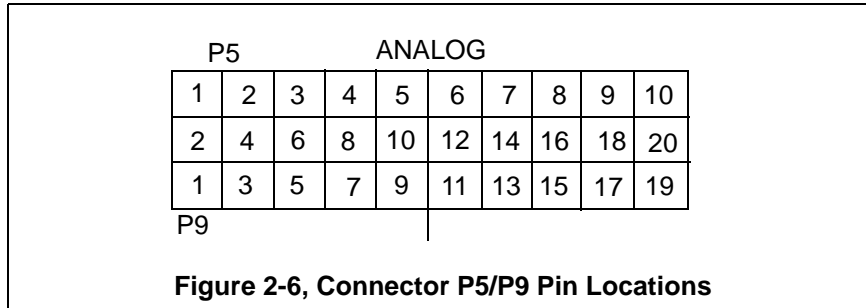

The definition of P5/P9 signals are shown in the table below.

Table 4: P5/P9, Analog Interface Connector

P5 Pin #	Signal	P9 Pin #	Signal	P9 Pin #	Signal
1	ADCINB0	1	GND	2	ADCINA0
2	ADCINB1	3	GND	4	ADCINA1
3	ADCINB2	5	GND	6	ADCINA2
4	ADCINB3	7	GND	8	ADCINA3
5	ADCINB4	9	GND	10	ADCINA4
6	ADCINB5	11	GND	12	ADCINA5
7	ADCINB6	13	GND	14	ADCINA6
8	ADCINB7	15	GND	16	ADCINA7
9	ADCREFM	17	GND	18	VREFLO *
10	ADCREFP	19	GND	20	No connect

* Connect VREFLO to AGND or VREFLO of target system for proper ADC operation.

2.3.5 P6, Power Connector

Power (5 volts) is brought onto the eZdsp™ F2804x via the P6 connector. The connector has an outside diameter of 5.5 mm. and an inside diameter of 2.5 mm. The position of the P6 connector is shown below.

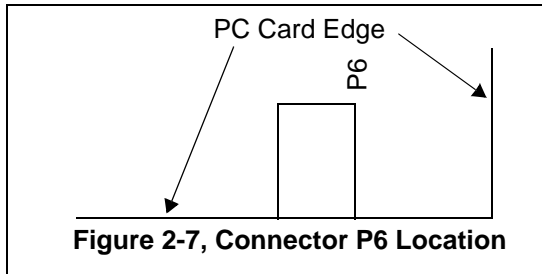

The diagram of P6, which has the input power is shown below.

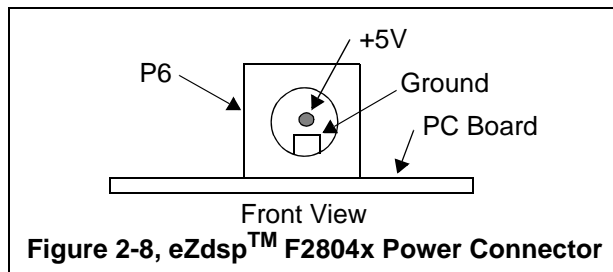

2.3.6 P10, RS-232 Connector

The eZdsp F2804x has an RS-232 connector which brings out the SCIA transmit and receive signals to be used as UART. This UART uses the MAX3238 RS-232 line driver and is routed to a male 9 pin D-connector, P10. The pin positions for the P10 connector as viewed from the edge of the printed circuit board are shown below.

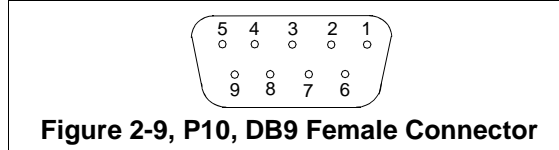

The pin numbers and their corresponding signals are shown in the table below. This corresponds to a standard dual row to DB-9 connector interface used on personal computers.

Table 5: P10, RS-232 Pinout

Pin #	Signal Name	Direction
1	No Connect	
2	PCRXDA	Out
3	PCTXDA	In
4	No Connect	
5	GND	N/A
6	No Connect	
7	No Connect	
8	No Connect	
9	No Connect	

2.3.7 Connector Part Numbers

The table below shows the part numbers for connectors which can be used on the eZdsp™ F2804x. Part numbers from other manufacturers may also be used.

Table 6: eZdsp™ F2804x Suggested Connector Part Numbers

Connector	Male Part Numbers	Female Part Numbers
P1	SAMTEC TSW-1-10-07-G-T	SAMTEC SSW-1-10-01-G-T
P2	SAMTEC TSW-1-20-07-G-T	SAMTEC SSW-1-20-01-G-T

*SSW or SSQ Series can be used

2.4 eZdsp™ F2804x Jumpers

The eZdsp™ F2804x has 3 jumpers, JP4, JP5, and JP6. JP4 will allow power to be supplied to the expansion headers. Jumper JP5 selects the ACDREFIN voltage. The JP6 jumper selects which GPIO pin (22 or 24) goes to Pinn33 of P8. The table below lists the jumpers and their function. The following sections describe the use of each jumper.

Table 7: eZdsp™ F2804x Jumpers

Jumper #	Size	Function	Position As Shipped From Factory
JP4	1 x 3	+3.3/5 Volts to P8 Pin 1,2 and P4, Pin 1	Not connected
JP5	1 x 2	Selects ADCREFIN voltage	Not connected
JP6	1 x 3	Selects GPIO22 or GPIO24 to Pin 33, P8	2 - 3, GPIO24 to Pin 33, P8

2.4.1 JP4, Voltage Jumper, +3.3/5 Volts for P8, P4

Jumpers JP4 is an unpopulated jumper on the bottom side of the board that provide either +3.3 volts or +5 volts to pins on the expansion connector. This jumper is shipped uninstalled to prevent accidental damage by connecting wires or circuitry to the expansion connector. The user may connect the jumper by installing a jumper wire or zero ohm resistor. The position of this jumper is shown in the figure below.

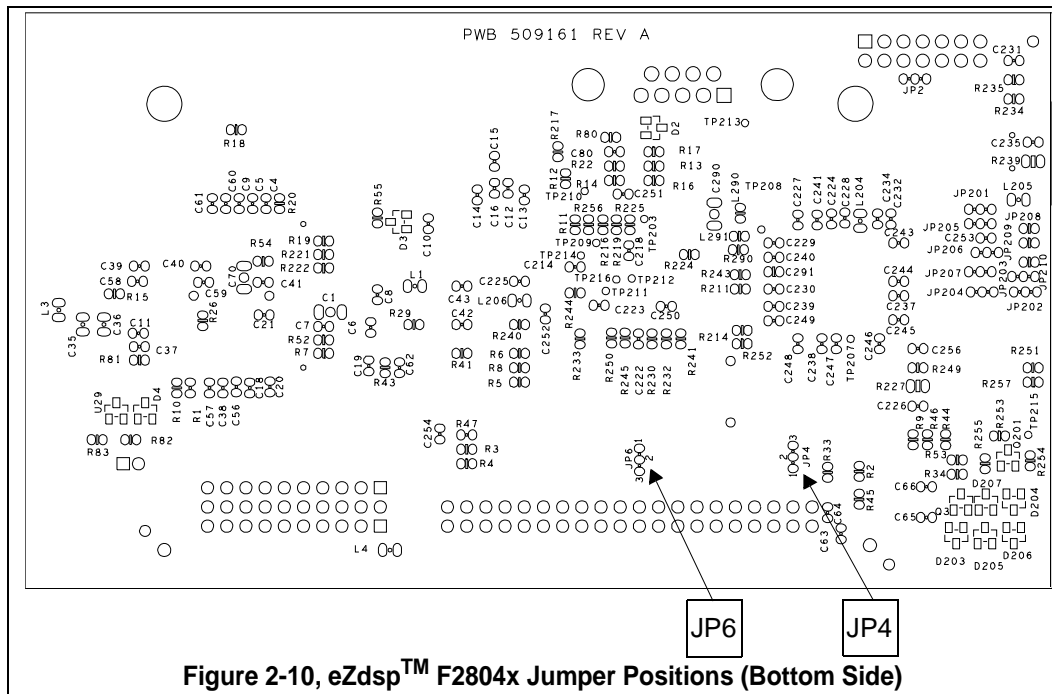

Jumper JP4 allows the user to provide either +3.3 or +5 volts to pins 1 and 2 of expansion connector P8.

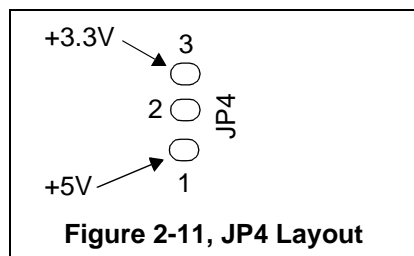

The table below shows the functions of the two positions of JP4.

Table 8: JP4, Voltage Jumper,+3.3/5 Volts for P8, P4

Position	Function
1 - 2	+5V connected to P8
2 - 3	+3.3 connected to P8

2.4.2 JP5, ADCREFIN Select

Jumper J5 is used to select ADCREFIN as the voltage reference for the analog to digital converter. When the jumper is shorted the +2.048 voltage level is routed to the ADCREFIN signal of the DSP. When the jumper is open the ADCREFIN floats.

2.4.3 JP6, GPIO22/GPIO24 Select

Jumper JP6 selects which signal, GPIO22 or GPIO24, to be routed to Pin 33, P8. When the 1-2 jumper position is selected GPIO22 is connected to pin 33, P8. The 2-3 selection will route GPIO24 to Pin 33, P8. The figure below shows the connector layout on the bottom side of the board.

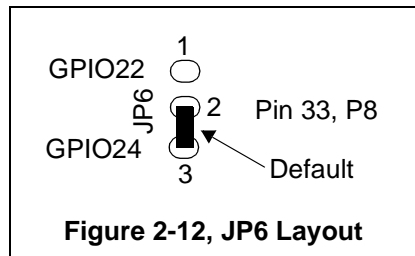

The table below shows the functions of the two positions of JP6.

Table 9: JP6, GPIO22/GPIO24 Select

Position	Function
1 - 2	GPIO22 connected to Pin 33, P8
2 - 3	GPIO24 connected to Pin 33, P8 *

* default

2.5 Switches

The eZdsp F2804x has 2 switches, SW1 and SW2, which are used to configure various functions on the board. The switches and their functionality are described in the following sections.

2.5.1 Switch SW1

The eZdsp F2804x has a 6 position switch, SW1, that allows the user to configure the board for their application. The function of each position on SW1 is shown in the table below.

Table 10: SW1 Switch Positions

Position	Function
1-3	Boot Mode Select
4	Serial EEPROM WP
5	Serial EEPROM Pullups
6	Serial EEPROM - A1

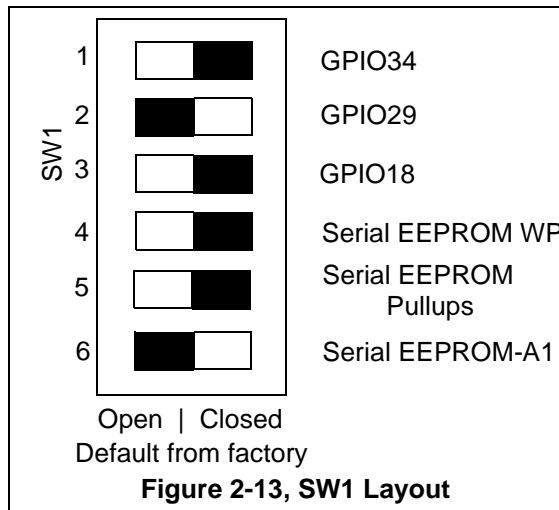

2.5.1.1 Switch SW1, Positions 1-3, Boot Mode Select

Positions 1-3 on switch SW1 are used to determine what mode the DSP will use for bootloading on power up. The options are shown in the table below.

Table 11: SW1, Positions 1-3

Position 3 GPIO18	Position 2 GPIO29	Position 1 GPIO34	Boot Mode
Open-1	Open-1	Open-1	Flash
Open-1	Open-1	Closed-0	SCI-A
Open-1	Closed-0	Open-1	SPI-A
Open-1	Closed-0	Closed-0	I ² C-A
Closed-0	Open-1	Open-1	Reserved
Closed-0	Open-1	Closed-0	M0 SARAM *
Closed-0	Closed-0	Open-1	OTP
Closed-0	Closed-0	Closed-0	I/O

* factory default

2.5.1.2 Switch SW1, Position 4, EEPROM Write Enable/Disable

Position 4 on switch SW1 is used to enable or disable the Write Enable for the EEPROM. When position 4 is in the “Closed” state the Write Protect to the EEPROM is disabled, therefore allowing the EEPROM to be written. When position 4 is in the “Open” state the EEPROM Write Protect is enabled, not allowing the EEPROM to be written. These positions are shown in the table below.

Table 12: SW1, Position 4

Position	Function
Closed-0 *	EEPROM WP Disabled (EEPROM can be written to) *
Open-1	EEPROM WP Enabled (EEPROM cannot be written to)

* factory default

2.5.1.3 Switch SW1, Position 5, Serial EEPROM Pull-ups

Position 5 on switch SW1 are used to select if the EEPROM is using pull up resistors. When position 5 is in the “Closed” state pull up resistors are used. When position 5 is in the “Open” state the pull-up resistors are not used. These positions are shown in the table below.

Table 13: SW1, Position 5

Position	Function
Closed-1 *	Pull up resistors used *
Open-0	Pull up resistors not used

* factory default

2.5.1.4 Switch SW1, Position 6, Serial EEPROM Address A1

Position 6 on switch SW1 are used to select if the address line A1 to the serial EEPROM is pulled high or low. When position 6 is in the “Closed” state A1 equals 1. When position 6 is in the “Open” state A1 equals 0. These positions are shown in the table below.

Table 14: SW1, Position 6

Position	Function
Closed-1	A1 = 1
Open-0	A1 = 0 *

* factory default

2.5.2 Switch SW2

Switch SW2 on the eZdsp F2804x has 4 positions that allow the user to configure the SCI MUX. The function of each position is shown in the table below.

Table 15: SW2 Switch Positions

Position	Function	Settings
1	SCIA/GPIO MUX Control	Open/High GPIO28, GPIO29 to expansion connector P8 Closed/Low GPIO28, GPIO29 to SCIA/CANA transceivers
2	SCIA/GPIO MUX Enable	Open/High GPIO28, GPIO29 isolated Closed/Low GPIO28, GPIO29 not isolated

The layout of switch SW2 is shown in the figure below.

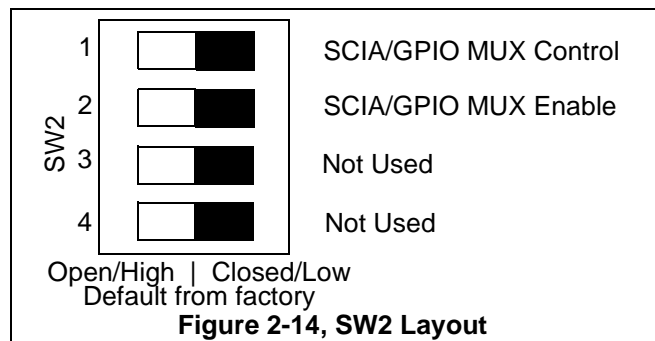

2.6 LEDs

The eZdsp™ F2804x has two light-emitting diodes. DS1 indicates the presence of +5 volts and is normally 'on' when power is applied to the board. DS2 is under software control and is tied to the GPIO34 pin on the DSP through a buffer. These are shown in the table below.

Table 16: LEDs

LED #	Color	Controlling Signal
DS1	Green	+5 Volts
DS2	Green	GPIO34 bit (GPIO34 high = on)

2.7 Test Points

The eZdsp™ F2804x has two test points. The signals they are tied to are shown in the table below.

Table 17: Test Points

Test Point	Signal
J1	Analog Ground
J2	Ground

Appendix A

eZdsp™ F2804x

Schematics

The schematics for the eZdsp™ F2804x can be found on the CD-ROM that accompanies this board. The schematics were drawn on ORCAD.

WARNING !

The TMS320F2804x supports +3.3V Input/Output levels which are NOT +5V tolerant. Connecting the eZdsp to a system with +5V Input/Output levels will damage the TMS320F2804x. If the eZdsp is connected to another target then the eZdsp must be powered up first and powered down last to prevent latchup conditions.

REV	DESCRIPTION	DATE	APPROVED
A	Initial Release	July 31, 2006	R.P.P.

SCHEMATIC CONTENTS

- 01 TITLE SHEET
- 02 TMS320F2804X DSP
- 03 EXPANSION INTERFACE
- 04 JTAG INTERFACE
- 05 RS232 INTERFACE
- 06 POWER INPUT
- 07 LAYOUT DIAGRAM

REV	DATE	BY	APP	APPLICATION

REV	DATE	BY	APP	APPLICATION

REV	DATE	BY	APP	APPLICATION

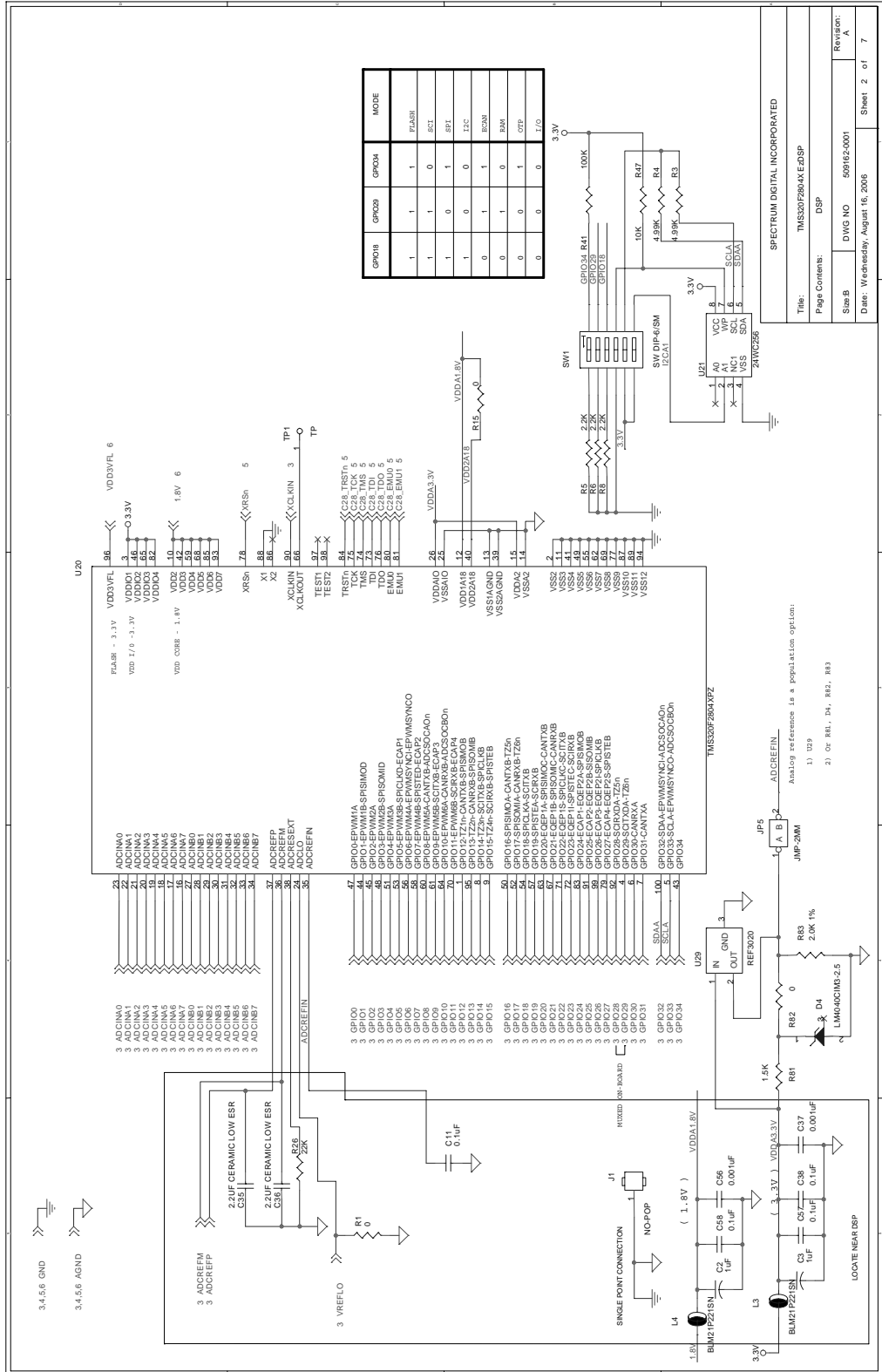

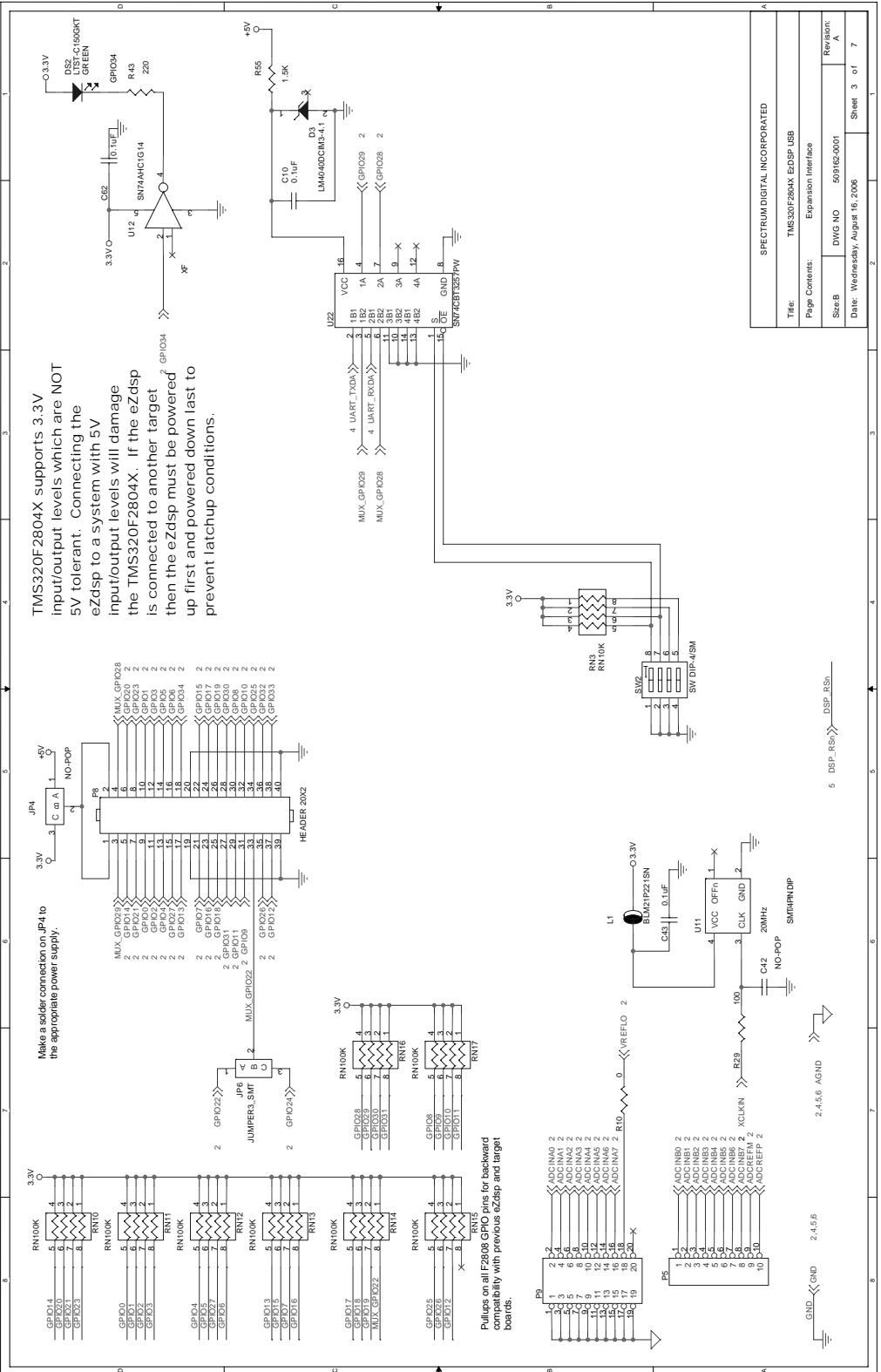

TMS320F2804X supports 3.3V input/output levels which are NOT 5V tolerant. Connecting with 5V eZdsp to a system with 5V input/output levels will damage the TMS320F2804X. If the eZdsp is connected to another target then the eZdsp must be powered up first and powered down last to prevent latchup conditions.

Make a solder connection on JP4 to the appropriate power supply.

Pullups on all F2808 GPIO pins for backward compatibility with previous eZdsp and target boards.

SPECTRUM DIGITAL INCORPORATED	
Title:	TMS320F2804X eZdsp USB Expansion Interface
Page Contents:	Expansion Interface
Size B:	DWG NO 509162-0001
Date:	Wednesday, August 16, 2006
Revision:	A
Sheet	3 of 7

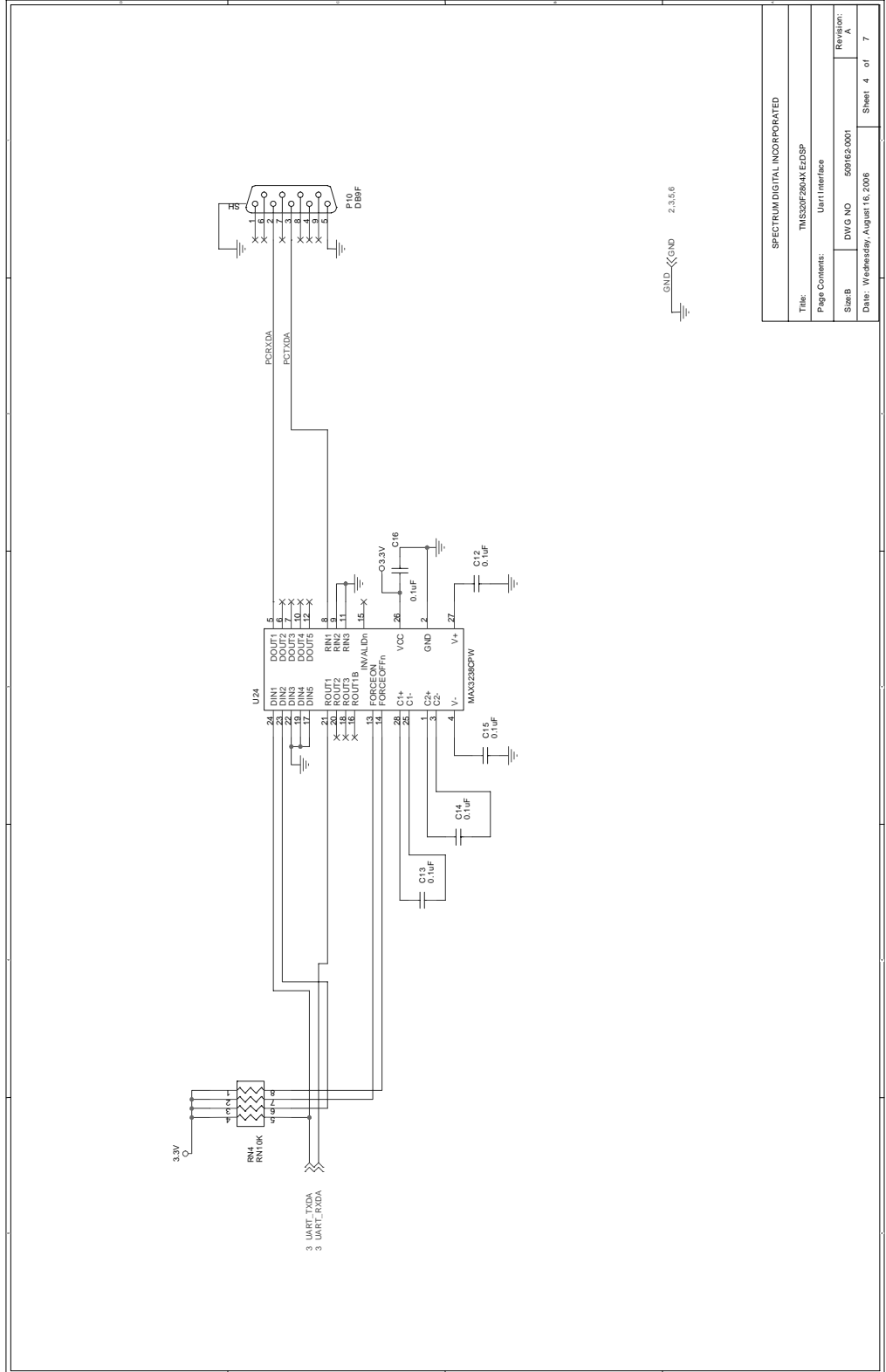

SPECTRUM DIGITAL INCORPORATED			
Title:	TMS320F2804K E2DSP		
Page Contents:	Uart1 Interface		
Sheet B	DWG NO	509162.0001	Revision: A
Date:	Wednesday, August 16, 2006		Sheet 4 of 7

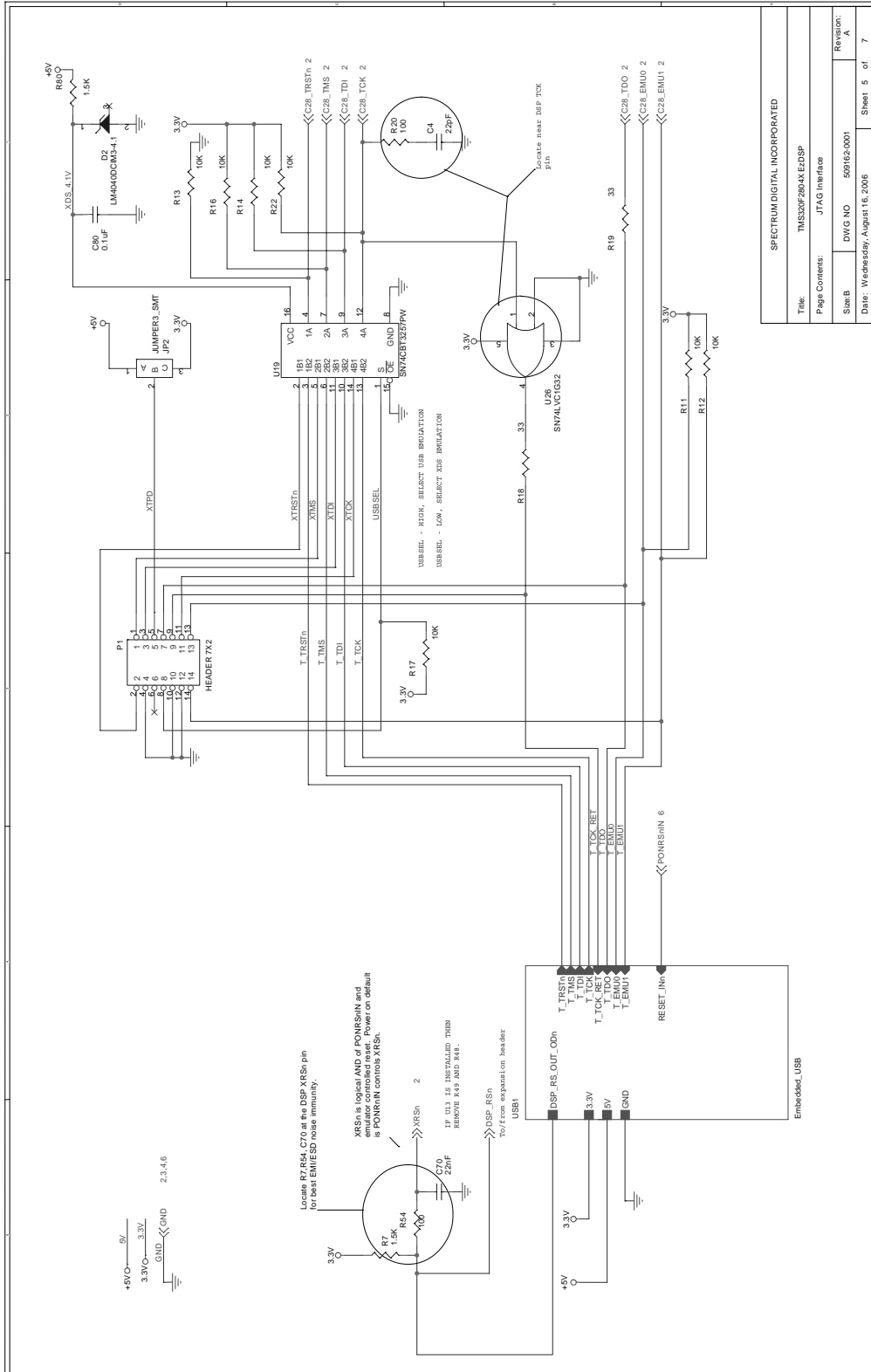

SPECTRUM DIGITAL INCORPORATED			
Title:	TMS320F2804x EZDSP		
Page Contents:	JTAG Interface		
Sheet:	DWG NO. 599163-0001	Revision:	A
Date:	Wednesday, August 16, 2006		Sheet 5 of 7

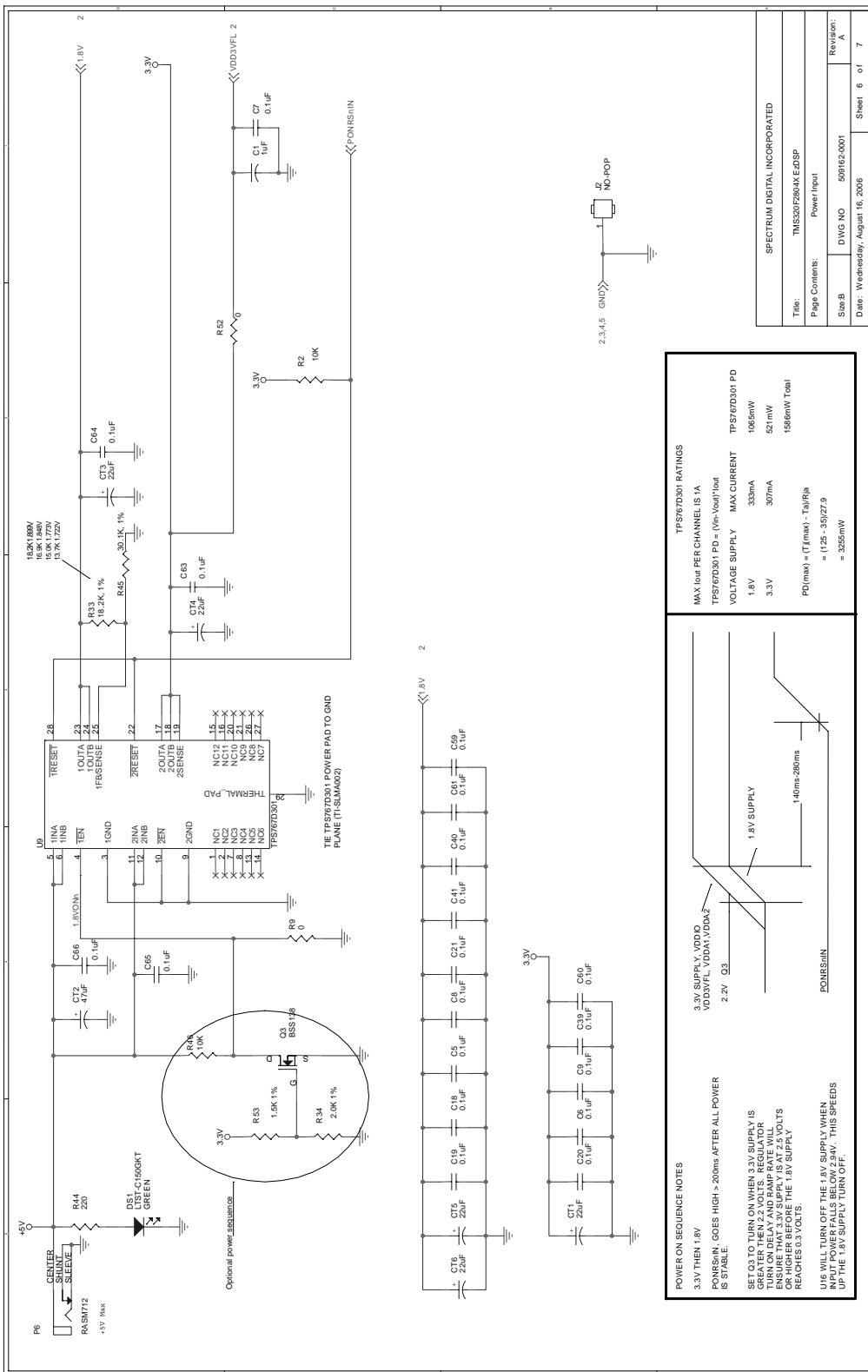

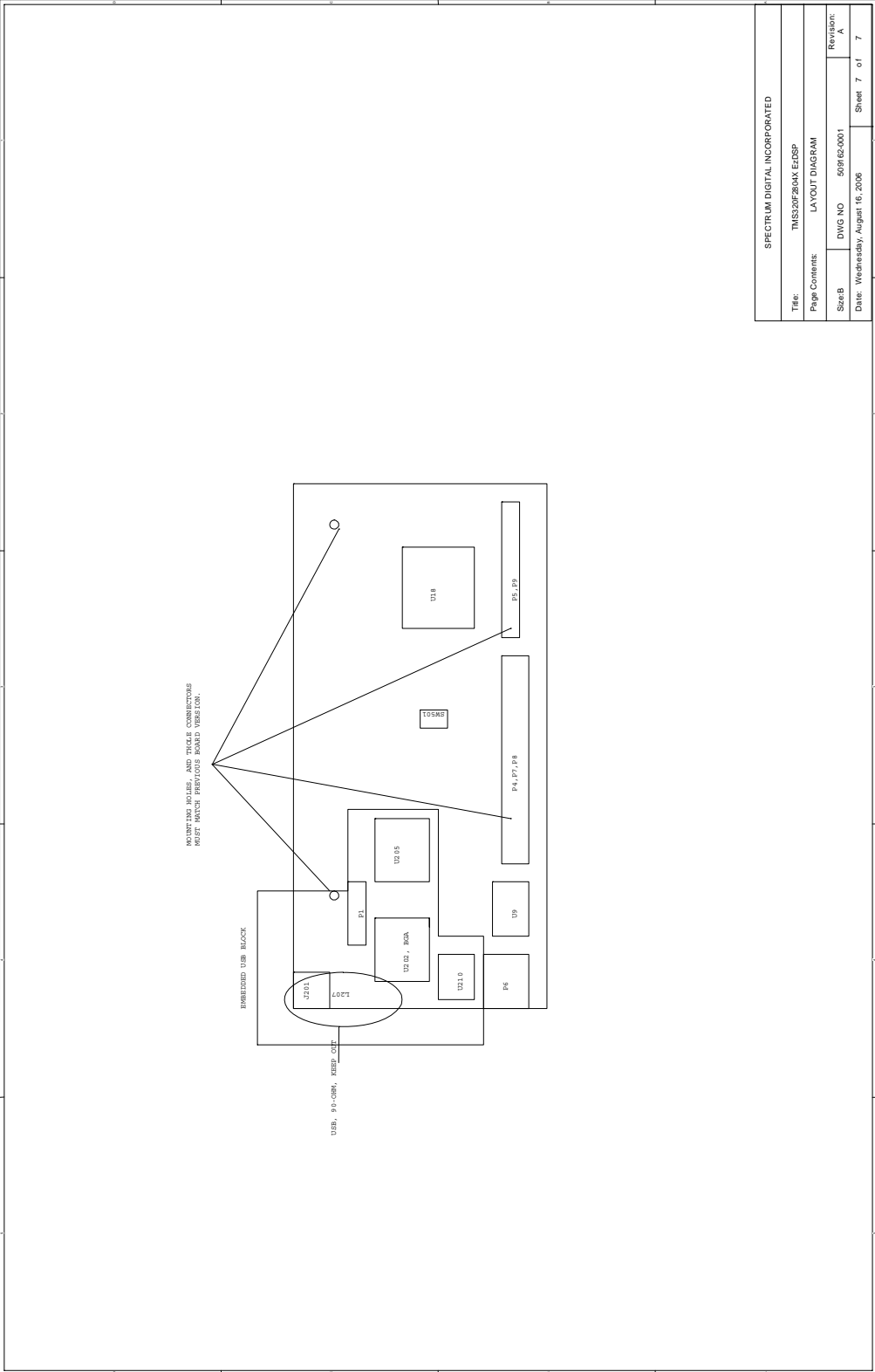

Appendix B

eZdsp™ F2804x

Mechanical Information

This appendix contains the mechanical information about the socketed and unsocketed versions of the eZdsp™ F2804x.

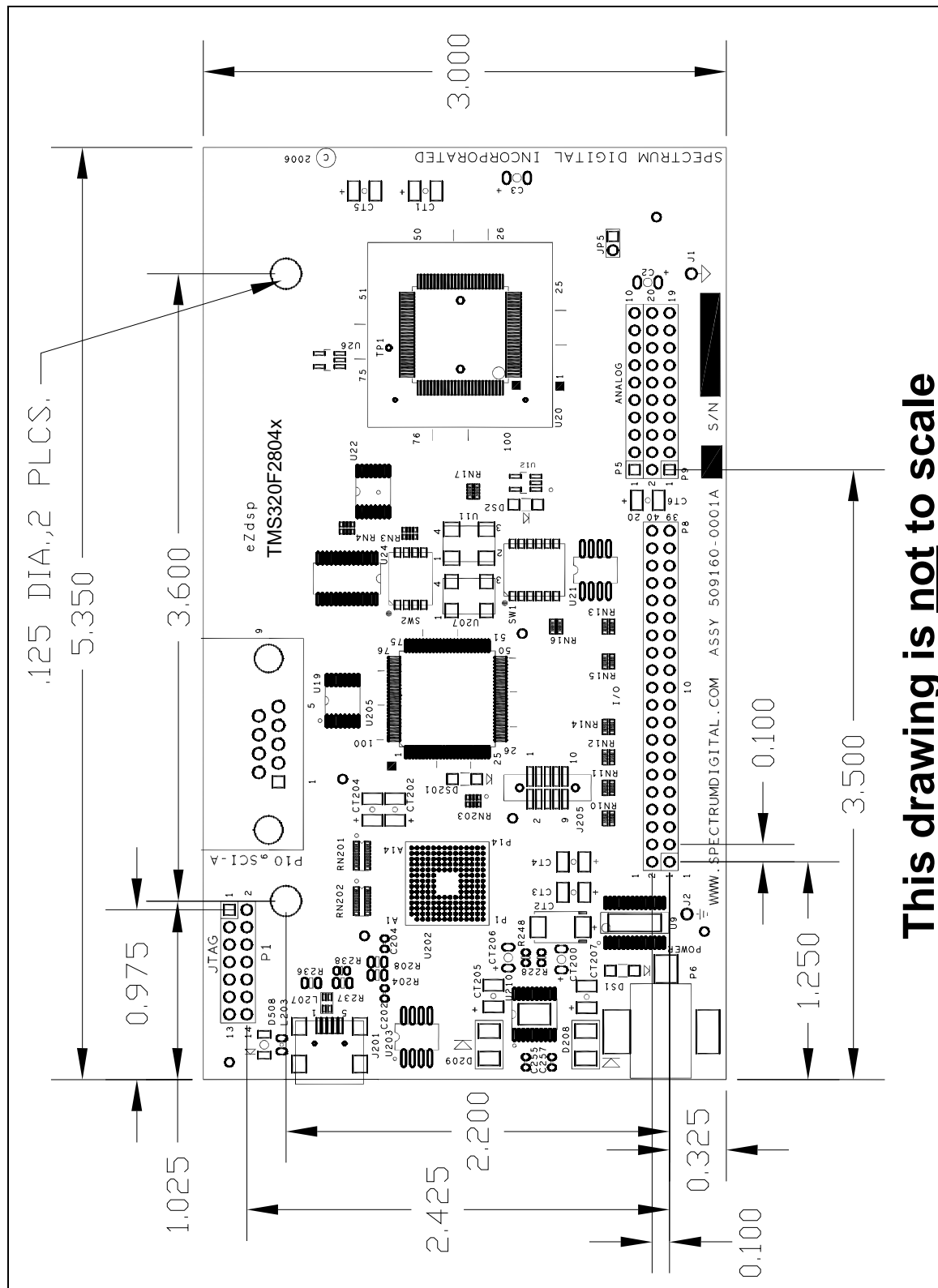

This drawing is not to scale

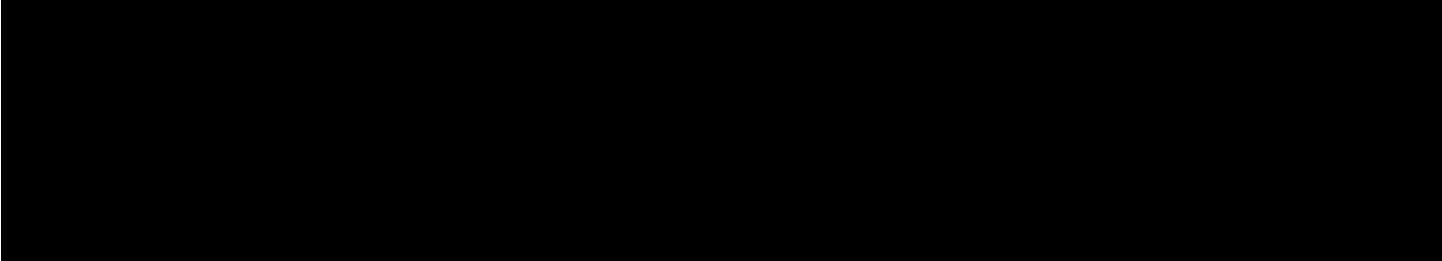

SPECTRUM
DIGITAL

INCORPORATED

Printed in U.S.A., November 2006
509165-0001 Rev. B

