

Assembly Instructions for - 37171

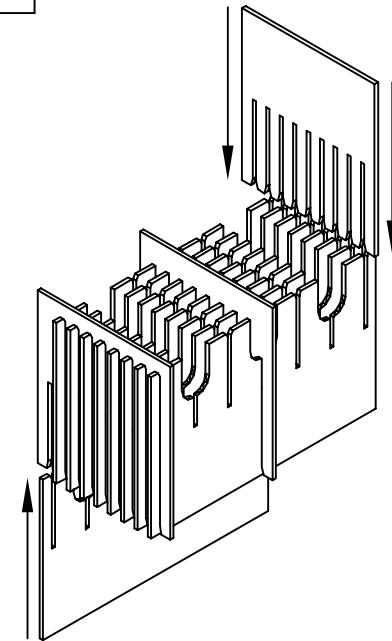
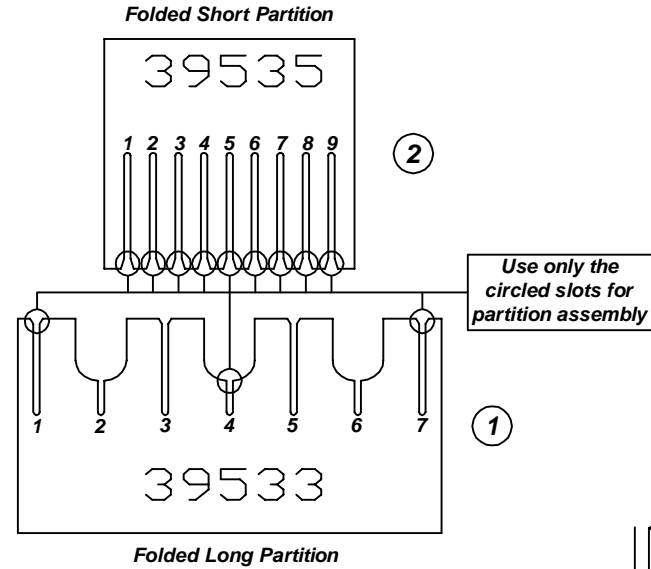
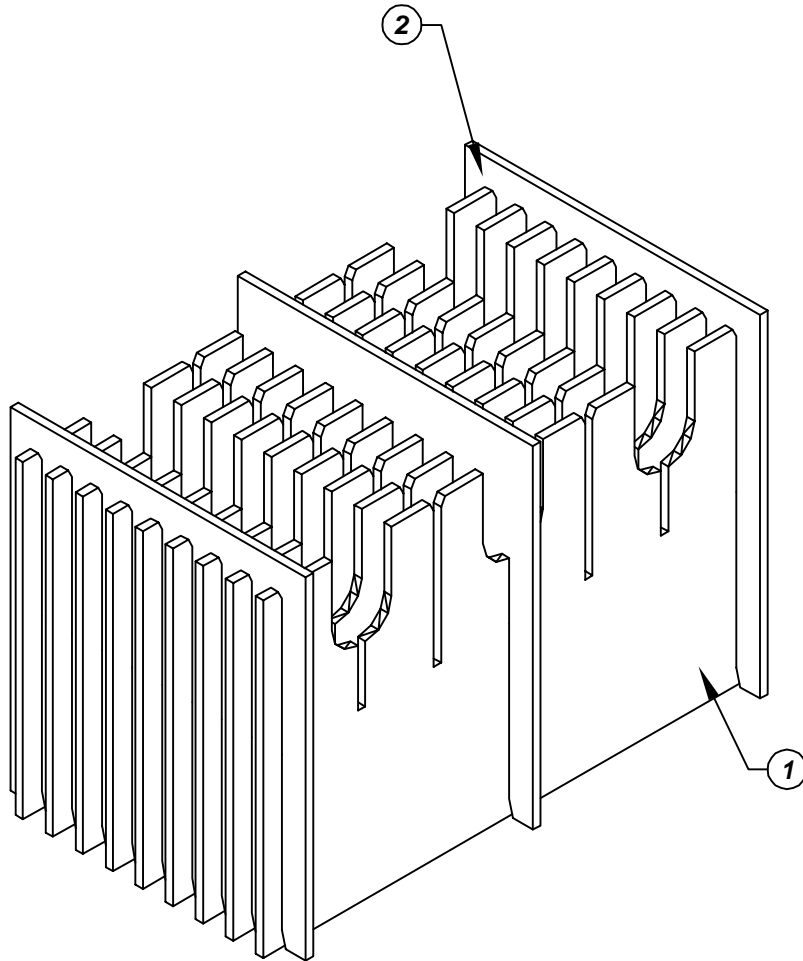

Made in America

F/N ①	Part # 39533	Dimensions: 20-7/8" x 16-5/8"	Description: 402-LP Long Partition	Qty: 9
F/N ②	Part # 39535	Dimensions: 22-3/8" x 9-13/16"	Description: 402-SP Short Partition	Qty: 3

37171 - 20 Cell Inplant Handler Cell Size - 11-1/4" x 7-1/4" x 3/4"

Notes:
For use with the following storage container & lid:
37502 - Storage Container
37550 - Lid

PROTEKTIVE PAK
13520 MONTE VISTA AVENUE, CHINO, CA 91710
PHONE (909) 627-2578, FAX (909) 363-7331
ProtektivePak.com



DRAWING NUMBER
IPH-37171

DATE
Dec.
2007